

FB100 FB400 FB900



General Description

The FB Series is a high performance process controller with a more advanced Brilliant II PID, autotuning, selectable sampling cycle time of 0.05/0.1/0.25 second and 0.1% of accuracy in short depth housing.

Applications include various plastic machines (extruders, injection machine, etc), electric furnaces, semiconductor, food processing, environmental chambers and many others.

Features

- ☆ High Accuracy with selectable sampling cycle time
- ☆ The depth of 60mm (FB100 : 74mm)
- ☆ Inter-controller Communication
- ☆ Brilliant II PID control
- ☆ Start-up tuning and Autotuning

Panel space saving

The FB Series has very short depth as a 1/16, 1/8 or 1/4 DIN size controller. The series was designed with a mounting bracket that allows close horizontal mounting of as many as six

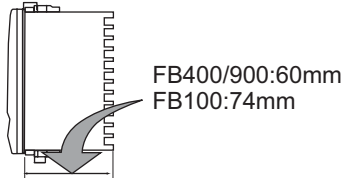

Numerous inputs and outputs

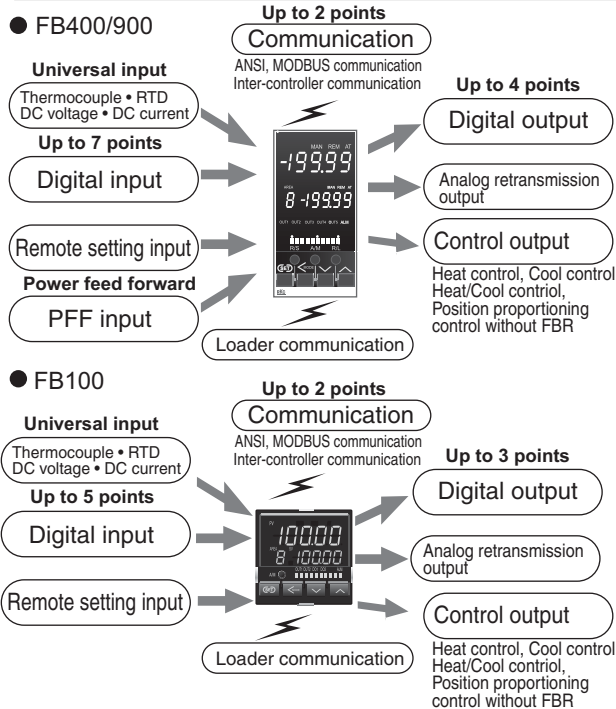

Easy maintenance

The internal assembly of the FB Series can be removed from the front.

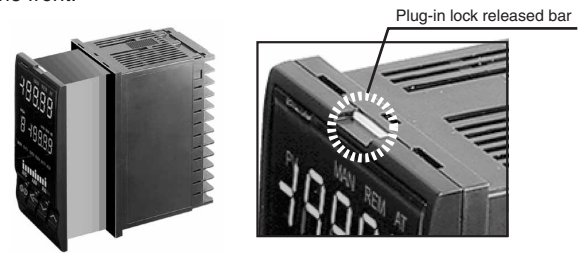

Direct Function Keys

Three direct function keys enable one-touch operation on frequently used functions such as Auto/Manual, Monitoring display scroll, and Memory area selection.

The keys can also be configured as RUN/STOP, Remote/Local, and Auto/Manual keys.

● FB400/900

1. Auto/Manual, Monitoring display scroll, Memory area selection

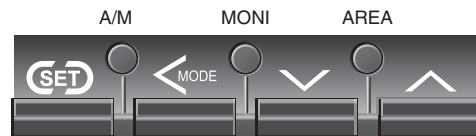

2. Auto/Manual, Remote/Local, RUN/STOP

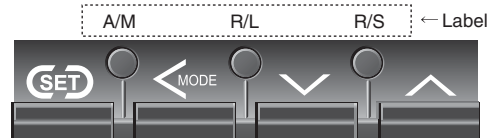

* Also possible to invalidate the direct mode selection key function.

● FB100

One function can be selected from the following list and assignable to the key:

- Auto/Manual, Monitoring display scroll, Memory area selection, Remote/Local, RUN/STOP
- (Default setting : Auto/Manual)

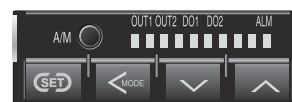

Features

Ramp / Soak Program Control

The FB900/400 Series temperature controller has Recipe (Multi-memory Area) function which stores up to 8 sets of control parameters.

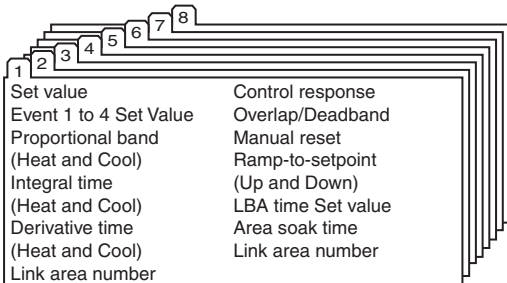

Up to 16-segment ramp/soak control is available by using the memory area function (ramp-to-set point UP and DOWN, soak time, link area number).

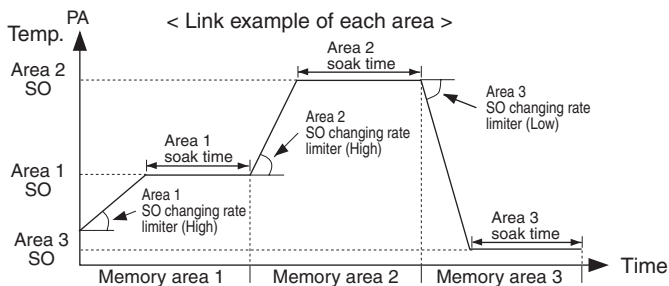

Numerous Inputs and Outputs

A maximum of seven event inputs can be specified. A maximum of five outputs can be specified, and various output functions (control output, analog retransmission, event up to 4) can be allocated in output logic operation.

- Available inputs and outputs depend on the specifications.

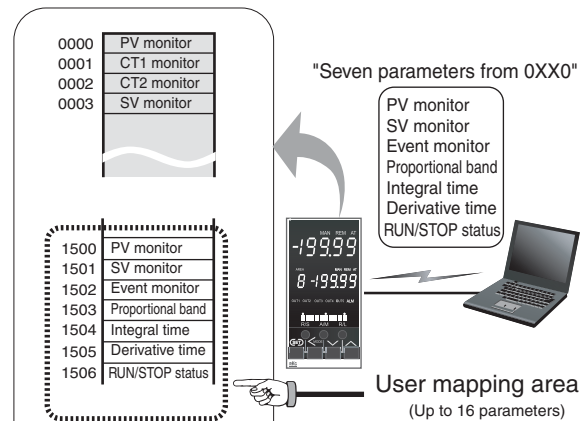

Inter-controller Communication

The FB Series has a second communication port (COM2) for inter-controller communication. It achieves more precise cascade control and ratio control by sending data via digital communication while conventional cascade controllers send data to slave controllers by analog signal with less resolution.

Auto-temperature-rise with Learning Function

Auto-temperature-rise with learning function achieves temperature uniformity at ramp-up without partial thermal expansion even when using multiple FB Series controllers.

- Up to 32 controllers with 16 groups can be configured.

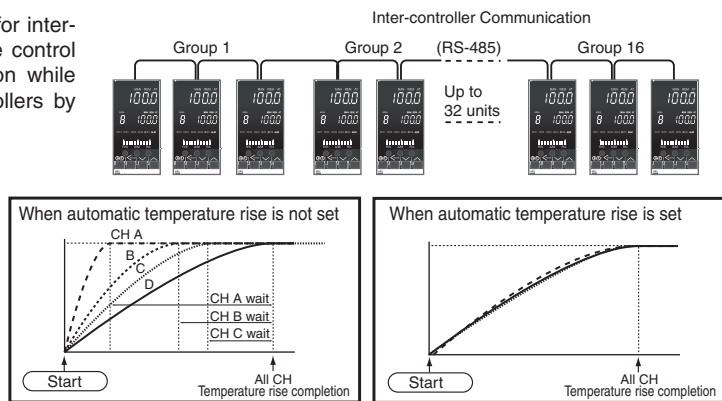

Temperature Ratio Setting

If the master controller changes the control set value, the slave controllers will also change the set values by following preset ratios to the master.

- Up to 32 controllers with 16 groups can be configured.

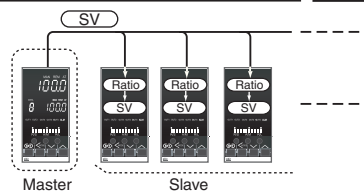

Cascade Control

It is effective when a thermal time-delay exists between the heat source and a control point. A maximum of 30 slave controllers can be connected to one master controller.

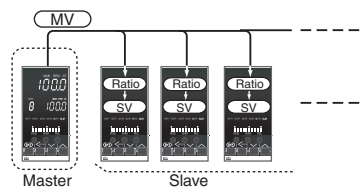

Group RUN/STOP Function

When RUN/STOP mode is changed on one controller in a group, the mode of all the other controllers in the same group will be also automatically changed.

- Up to 32 controllers with 16 groups can be configured.

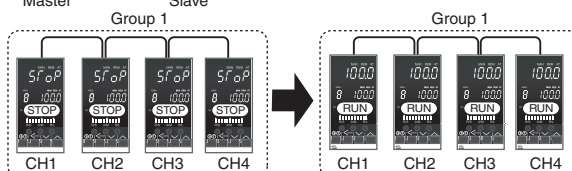

(Note) Time lag among controllers caused by inter-controller communication is (Max.70ms) x (number of controllers connected). Please consider the time lag of inter-controller communication for high-speed process control in which process changes rapidly.

Features

Brilliant II PID Control

● Selectable PID control algorithm

PID control algorithm is selectable in the FB Series to achieve the most precise control for various applications.

PV Derivative PID : suitable for fixed setpoint control (Factory setting)

Deviation Derivative PID : suitable for ramp control using ramp-to-setpoint function and cascade control.

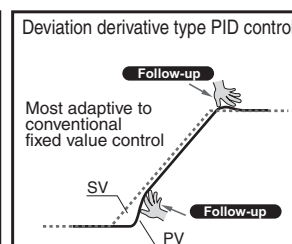
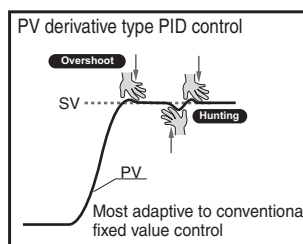

● Selectable sampling time among 50ms, 100ms, and 250ms.

Selectable sampling time makes the FB Series suitable for any application ranging from pressure control requiring fast response to precise control requiring highest resolution. The selections are 100ms (factory setting) usually suitable for most of standard applications, 50ms for fast response applications, and 250ms for precise control requiring high-resolution. The PID parameters can be set in 1/10 unit which supports fast and accurate control. Ramp-to-setpoint and output-change-limiter functions are each settable for UP and DOWN so that a special heater can be controlled precisely.

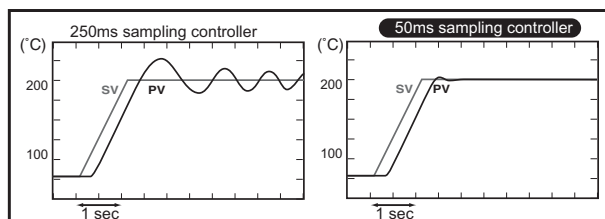

● Advanced Heat/Cool PID algorithm with Undershoot Suppression

Advanced Heat/Cool PID algorithm achieves stable control by the Undershoot Suppression (USS) function, and independent P-I-D settings for both Heat and Cool which are effective for applications with strong cooling gain. Control Response type selection is settable to avoid overshoot at start-up and against external disturbance. The FB Series also offers selection of water cool and air cool PID control algorithm.

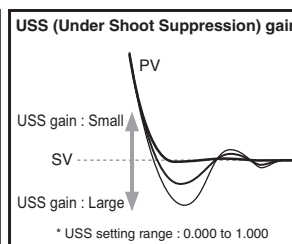
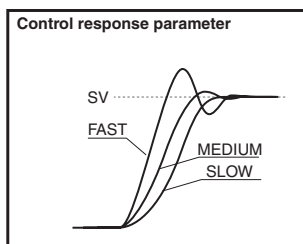

● Configurable control type

The control type is configurable among Heat, Cool, Heat/Cool, and position proportioning.

Autotuning

● Autotuning to calculate optimum PID parameters

The improved Autotuning algorithm calculates optimum PID parameters. For Heat/Cool control, PID parameters for both sides (Heat and Cool) are calculated.

● Start-up tuning to eliminate time for autotuning

Start-up tuning eliminates time required for conventional autotuning as it calculates optimum PID values by temperature characteristics at start up. It is useful in applications which require a long time for conventional autotuning. The timing of activation of start-up tuning can be selected from at power-up, at setpoint change, and at power-up/setpoint change. It is also settable to Only-once or always-ON.

- Validity/invalidity of the startup tuning function can be set.
- Heater power needs to be turned on simultaneously with or before turning on power to the temperature controller.
- If start-up tuning does not calculate suitable PID values due to characteristics of application, use Autotuning function.

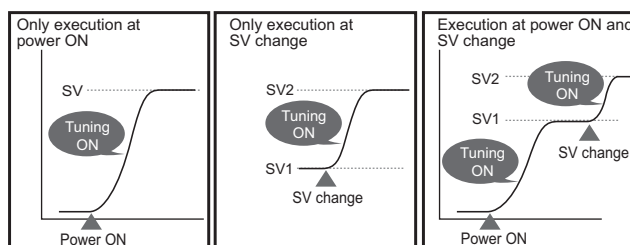

● Output limiters high and low for autotuning

Output limiters high and low for autotuning enables autotuning to be used with any application in which the output has to be within limited range, even during autotuning. High and low are independently settable.

AT function when limiter is not effective. AT function when limiter is effective.

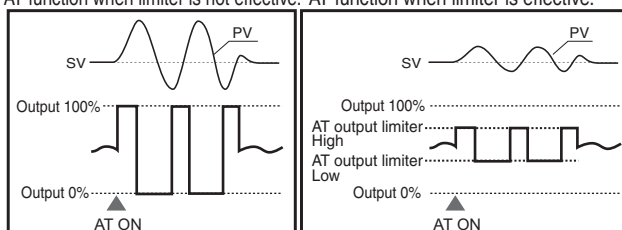

Features

Setup and Data Monitoring

The FB Series has the loader port (provided as standard) to connect to a PC USB port with Windows2000/XP. The standard port allows setup and data logging to be managed by the PC. The FB Series is recognized as an external device on the PC.

● Easy data monitoring/logging with Win-UCI

The Win-UCI can store maximum 8,000 points of data. Data can be exported as an electronic file in CSV format. It has a trend graph function and data monitoring function.

"Win-UCI" software for setup & data logging is free.
Simply download "Win-UCI" from the RKC Instrument website (www.rkcinst.com).

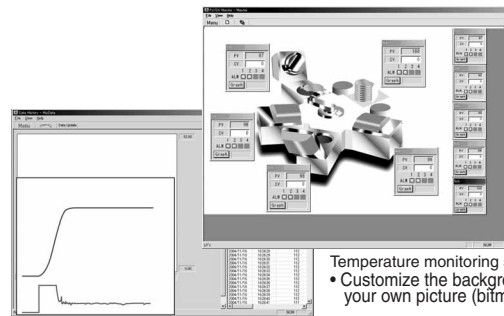
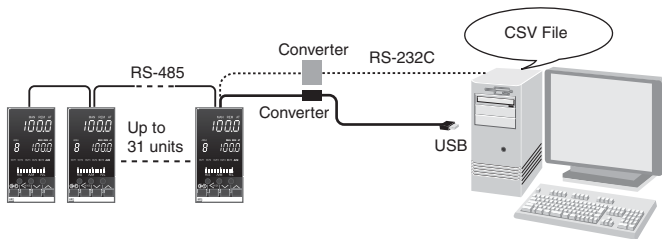

Temperature monitoring screen
• Customize the background with your own picture (bitmap format)

Data logging and trend graph screen

● Easy setup with Win-UCI

Using the Win-UCI, the controller setup and parameter settings can be done from a PC. The parameter settings can be stored on the PC making it easy to copy the same parameters to other FB Series controllers.

- The instrument must have a hardware required for selected functions.

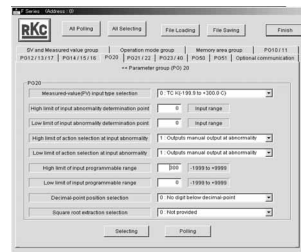

Data setting screen

● No power supply cable necessary at setup

When setting up the FB Series via the loader port, the power can be supplied from the PC via the USB port so no power supply cable is necessary. Just connect the cable to the FB Series and setup is ready to go.

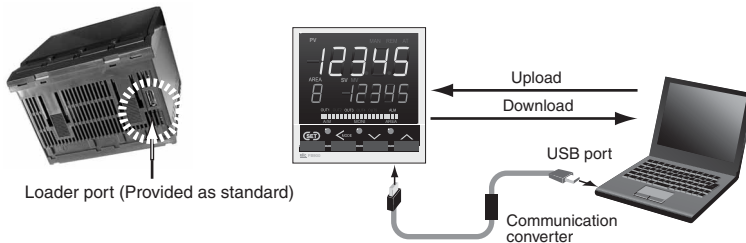

Loader port (Provided as standard)

Communication converter

Communication converter : COM-K (Unit : mm)

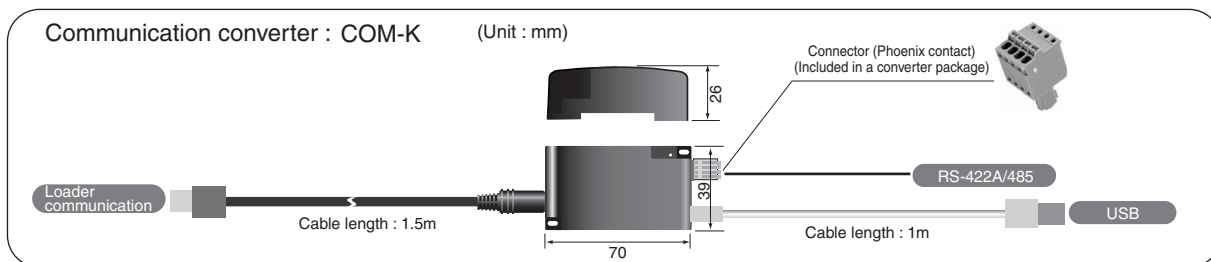

Reinforced Insulation, Lead-free PCBs, Low Power Consumption

● Reinforcement Insulated Power Supply Circuit

Power supply circuit of the FB Series has been designed to be reinforcement insulated. It saves cost to perform basic insulation on the equipment side.

<Requirements for electrical equipment according to safety standards>

The safety standards on electrical equipment (IEC 61010-1 and JISC 1010-1) request that the secondary side of the equipment which may be touched by the operator should be double insulated or reinforcement insulated* from high voltage causing electric shock.

- Insulation safeguarding personnel from electric shock which is equal to double insulation or higher is called "reinforced insulation".

● Lead-free Design complying with EU Directive

The FB Series uses lead-free PCBs complying with EU Directive *.
* WEEE Directive (Waste Electronics/Electrical Equipment Directive) and RoHS Directive (Directive of Restricting the use of Harmful Materials for Electrical Products)

● Low Power Consumption, Low Heat Generation

The power consumption is 30% less than the equivalent model of RKC REX-F900. The saving is 5VA per controller at 240VAC. It also generates less heat and it helps keep temperature low inside the control cabinet.

Specifications

Input

Input

Universal input

- a) Temperature, Current, Low voltage input group
 Thermocouple : K, J, R, S, B, E, T, N (JIS/IEC), PLII (NBS),
 W5Re/W26Re (ASTM), U, L (DIN)

- Influence of external resistance : Approx. 0.2μV/Ω
 - Input break action : Up-scale / Down-scale (Selectable)
- RTD : Pt100 (JIS/IEC), JPt100 (JIS)

- Influence of input lead resistance : Approx. 0.01[%/Ω] of reading
 - Maximum 10Ω per wire
 - Input break action : Up-scale
- Low voltage : 0 to 1V DC, 0 to 100mV DC, 0 to 10mV DC,
 -100 to +100mV DC, -10 to +10mV DC

- Input break action : Up-scale / Down-scale (Selectable)
- Current : 4 to 20mA DC, 0 to 20mA DC

- Input break action : Uncertain (indicates a value around 0mA)

b) High voltage input group

- High voltage : 0 to 5V DC, 1 to 5V DC, 0 to 10V DC, -1 to +1V DC
 • Input break action : Uncertain (indicates a value around 0V)

Sampling Time

0.1 sec

- 0.05sec or 0.25sec is available.

Input Digital Filter

0.1 to 100.0 sec (OFF when 0 is set.)

PV Bias

-span to +span

PV Ratio

0.500 to 1.500

Square Root Extraction

Equation : $PV = \sqrt{\text{Input value} \times \text{PV ratio} + \text{PV bias}}$

Low level cut OFF : 0.00 to 25.00% of span

Performance

Measuring Accuracy

a) Thermocouple

Type : K, J, T, E, N, PLII, U, L

Less than -100°C (-148°F) : ±1.0°C (±1.8°F)

-100 to 500°C (-148 to 932°F) : ±0.5°C (±0.9°F)

More than 500°C (932°F) : ±(0.1% of Reading + 1 digit)

Type : N, S, R, W5Re/W26Re

Less than 0°C (32°F) : ±2.0°C (±3.6°F)

0 to 1000°C (-148 to 1832°F) : ±1.0°C (±1.8°F)

More than 1000°C (1832°F) : ±(0.1% of Reading + 1 digit)

Type : B

Less than 400°C (752°F) : ±70.0°C (±126°F)

400 to 1000°C (752 to 1832°F) : ±1.4°C (±2.5°F)

More than 1000°C (1832°F) : ±(0.1% of Reading + 1 digit)

Cold junction temperature compensation error

±1.0°C (1.8°F) [at 5 to 40°C (41 to 104°F)]

Within ±1.5°C (±2.7°F)

[Between -10 and 5°C (14 to 41°F), 40 and 50°C (104 to 122°F)]

b) RTD

Less than 200°C (392°F) : ±0.2°C (±0.4°F)

More than 200°C (392°F) : ±(0.1% of Reading + 1 digit)

c) DC voltage and DC current

±(0.1% of span)

- Close horizontal mounting error : ±1.5°C (±2.7°F)

Insulation Resistance

More than 20MΩ (500V DC) between measured terminals and ground

More than 20MΩ (500V DC) between power terminals and ground

Dielectric Strength

1000V AC for one minute between measured terminals and ground

Control

Control Method

a) Brilliant II PID control

- Available for reverse and direct action.

b) Brilliant PID control (Heat/Cool type)

c) Position proportioning control without feedback resistance.

- a), b), c) is selectable.

Autotuning Method

a) For PID control (Direct action/Reverse action)

b) For Heat/Cool PID control (For extruder, air cooling type)

c) For Heat/Cool PID control (For extruder, water cooling type)

d) For Heat/Cool PID control

Startup tuning

The condition to activate Startup Tuning is selectable among a) to g)

a) At power-on, one-time tuning

b) At SV change, one-time tuning

c) At power-on and SV change, one-time tuning

d) At power-on, always on

e) At SV change, always on

f) At power-on and SV change, always on

g) Function off

(Not available for Heat/Cool PID control type)

Major Setting Range

Set value :

Same as input range.

Proportional band :

0 to input span (Temperature input)

0.0 to 1000.0% of span (Voltage, Current input)
 (ON/OFF control when P = 0)

Integral time :

0 to 3600sec. or 0.0 to 1999.9sec.

(selectable)

Derivative time :

0 to 3600sec. or 0.0 to 1999.9sec.

(selectable)

Cool-side proportional band : 1 to input span (Temperature input)

0.1 to 1000.0% of span (Voltage, Current input)

Cool-side integral time :

0 to 3600sec. or 0.0 to 1999.9sec.

(selectable)

Cool-side derivative time :

0 to 3600sec. or 0.0 to 1999.9sec.

(selectable)

Deadband/Overlap :

-span to +span (Temperature input)

-100.0 to +100.0% of span (Voltage, Current input)

Control response :

Slow, Medium, Fast

Ramp-to-setpoint :

0 to span per Time

(Time is selectable between 1 and 3600 sec)

(Up/Down individual setting)

Output limiter :

-5.0 to +105.0% (High/Low individual setting)

Cool-side output limiter : -5.0 to +105.0% (High/Low individual setting)

Output change rate limiter : 0.0 to 100.0%/sec. (Up/Down individual setting)

Cool-side output change rate limiter :

0.0 to 100.0%/sec. (Up/Down individual setting)

Proportional cycle time : 0.1 to 100.0 sec.

Cool-side proportional cycle time :

0.1 to 100.0 sec.

Manual reset :

-100.0 to +100.0%

Output at control stop mode : -5.0 to 100.5% (Heat/Cool individual setting)

Motor Valve Control (position proportioning control type only)

Motor time :

5 to 1000 sec. (full open to full close)

Integral output limiter :

OFF, 100.0 to 200.0% of motor time

Neutral zone :

0.1 to 10.0%

Differential gap :

0.1 to 5.0%

Valve action at a stop mode : a) CLOSE : OFF, OPEN : OFF

b) CLOSE : ON, OPEN : OFF

c) CLOSE : OFF, OPEN : ON

• a), b), c) is selectable.

Memory area

Number of memory area : 8 memory areas

Setting item :

Set value (SV), Proportional band, Integral time,

Derivative time, Cool-side proportional band,

Cool-side integral time, Cool-side derivative time,

Deadband/Overlap, Control response,

Manual reset, Ramp-to-setpoint (Up/Down),

Event set vale, LBA time, LBA deadband,

Soak time : 0 min 0.00 sec to 199 min 59 sec or

0 hr 00 min to 9 hr 59 min

(selectable)

Linking area number : OFF, 1 to 8

Main Output

Number of Main Output

Up to 2 points (OUT1, OUT2)

Output Items

Control output, HBA output, FAIL output

Output Type

Relay output :

Form A contact, 250V AC 3A (resistive load)

Voltage pulse output :

0/12V DC

(Load resistance : More than 600Ω)

Current output :

4 to 20mA DC, 0 to 20mA DC

(Load resistance : Less than 600Ω)

Continuous voltage output :

0 to 1V DC, 0 to 5V DC, 1 to 5V DC, 0 to 10V DC

(Load resistance : More than 1kΩ)

SSR (Triac) output :

Rated current : 0.5A

Open collector output :

Load voltage : Less than 30V DC,

Maximum load current : Less than 100mA

ON voltage : Less than 2V DC (at 100mA)

Specifications

Digital Input •FB100 (DI 1 to 5 : Optional) •FB400/900 (DI 1 to 4 : Optional, DI 5 to 7 : Standard)

Number of Inputs

FB100 : Up to 5 points (DI 1 to 5)
FB400/900 : Up to 7 points (DI 1 to 4, DI 5 to 7)

Input Rating

Non-voltage contact input

Functions

Memory area selection (Area set/No area set is selectable)
RUN/STOP, Remote/Local, Auto/Manual, Alarm interlock reset
• Selectable (See digital input allocation table)

Remote Setpoint Input •FB100: Optional •FB400/900: Standard

Input

DC voltage (Low), Current : 0 to 1V DC, 0 to 100mV DC, 0 to 10mV DC
4 to 20mA DC, 0 to 20mA DC

DC voltage (High) : 0 to 5V DC, 1 to 5V DC, 0 to 10V DC

• PV input and remote setpoint input are not isolated for each other.
• Universal input

Sampling time

0.1 sec (with measuring input sampling time of 0.05 sec)
0.2 sec (with measuring input sampling time of 0.1 sec)
0.5 sec (with measuring input sampling time of 0.25 sec)

Accuracy

0.1% of span

Digital Output

•FB100: Standard
•FB400/900: Optional

Number of Sub Output

FB100: Up to 2 points (DO1, DO2)
FB400/900: Up to 4 points (DO1 to DO4)

Output Items

Event output, Heater break alarm (HBA), FAIL

Output Type

Relay output : Form A contact, 250V AC 1A (resistive load)

Event (Alarm)

•FB100: Standard
•FB400/900: Optional

Number of Event Setting

Up to 4 points (Event 1 to 4)

Alarms

Type : Deviation High, Low, High/Low, Band,
Process High, Low
Set value High, Low
MV value High, Low
Cool side MV value (MV) High, Low
FBR value High, Low
Control Loop Break Alarm (LBA)

Setting range

Deviation : - (Input span) to + (input span)
Differential gap : 0 to input span
Process, Set value : Same as input range
Differential gap : 0 to input span
MV value, FBR valued : -5.0 to +105.0%
Control loop break alarm (LBA)
: LBA time : 0 to 7200 sec. (OFF by setting zero)
LBA deadband : 0 to input span

Output

Assignable to digital output

Other Functions

- Hold/Re-hold action (Valid for deviation/band/process alarm only)
 - Hold action is activated at Power-up and STOP to RUN.
 - Re-hold action is activated at Power-up, STOP to RUN, and the control set value change.
- Event action is configurable in case of input abnormality.
- Energized/de-energized action is configurable.
- Delay timer : 0.0 to 600.0 sec
- Interlock (latch) function is configurable.

Heater Break Alarm (Optional)

Number of CT Input

Up to 2 points

CT Input type

CTL-6-P-N (30A), CTL-12-S56-10L-N(100A)
• Selectable

Accuracy

± 5% of input value or ± 2A (whichever is larger)

Display range

0.0 to 100.0A

Output

Assignable to output 2 or digital output (DO2 to 4).

Power feed forward input (FB400/900 only, Optional)

• Exclusive power feed transformer is required.

Analog Retransmission Output (Optional)

Number of Outputs

1 point

Output types

Measured value (PV), Deviation (DEV), Set value (SV), Manipulated output value (MV)

Output Signal

Current output : 4 to 20mA DC, 0 to 20mA DC
(Load resistance : Less than 600Ω)
Continuous voltage output : 0 to 1V DC, 0 to 5V DC, 1 to 5V DC, 0 to 10V DC
(Load resistance : More than 1kΩ)

Feedback Resistance (FBR) Input (Optional)

Resistance value

Standard : 100 to 10kΩ (factory default 135Ω)

Sampling time

0.1 sec (with measuring input sampling time of 0.05 sec)
0.2 sec (with measuring input sampling time of 0.1 sec)
0.5 sec (with measuring input sampling time of 0.25 sec)

• Not available with PFF or CT 2 input.

Communications

(Optional)

Number of communications : Up to 2 points

Communication method : COM1: RS-485, RS-232C, RS-422A
•RS-232C: FB400/900 only
COM2: For Inter-controller communication

Communication speed : 2400, 9600, 19200, 38400 BPS

Protocol : ANSI X3.28(1976) 2.5 A4
MODBUS

Bit format

Start bit : 1
Data bit : 7 or 8 •For MODBUS 8 bit only
Parity bit : Without, Odd or Even
Stop bit : 1 or 2

Maximum connection : RS-485 : 32 units (Including host)
RS-422A : 16 units (Including host)
RS-232C : 1 unit

Communication to Controller : Automatic temperature rise, Cascade control,
Temperature ratio setting, Group STOP/RUN

Waterproof/Dustproof

(Standard)

NEMA4X, IP66

• Waterproof/Dustproof protection only effective from the front in panel mounted installation.

General Specifications

Supply Voltage

- 90 to 264V AC (Including supply voltage variation)
[Rating : 100 to 240V AC] (50/60Hz selectable)
- 21.6 to 26.4V AC (Including supply voltage variation)
[Rating : 24V AC] (50/60Hz selectable)
- 21.6 to 26.4V DC (Ripple rate 10% p-p or less) [Rating:24VDC]

Power Consumption

FB100 : Less than 8.1VA for AC type (at 240V AC)
Less than 5.3VA for 24V AC type
Less than 142mA for 24V DC type
FB400 : Less than 11.9VA for AC type (at 240V AC)
Less than 8.2VA for 24V AC type
Less than 250mA for 24V DC type
FB900 : Less than 13.0VA for AC type (at 240V AC)
Less than 9.3VA for 24V AC type
Less than 300mA for 24V DC type

Power Failure Effect

A power failure of 20m sec or less will not affect the control action.
If power failure of more than 20m sec occurs, controller will restart with the state of HOT start 1, HOT start 2 or COLD start (selectable)

Self-Diagnostic Function

Adjustment data check, Back-up check, A/D converter check, etc.

Operating Environments : -10 to 50°C [14 to 122°F]

5 to 95% RH.

Absolute humidity : MAX. W.C 29.3g/m³ dry air at 101.3kPa.

Memory Backup : Backed up by non-volatile memory (FRAM)

- Data retaining period : Approx. 10 years
- Number of writing : Approx. 1,000,000,000,000,000 times.
(Depending on storage and operating conditions.)

Net Weight

FB100: Approx. 150g, FB400 : Approx. 230g, FB900 : Approx. 290g

External Dimensions (W x H x D)

FB100 : 48 x 48 x 740mm, FB400 : 48 x 96 x 60mm, FB900 : 96 x 96 x 60mm

Temperature/Process Controller FB 100/400/900

Model and Suffix Code

● FB100

Specifications		Model and Suffix Code	
		Hardware coding only	Quick start code 1
Model	FB100 (48 x 48mm 1/16 DIN size)	-□□-□*□/□□-□□□□/ Y	
Output 1 (OUT1)	Relay contact output	M	
	Voltage pulse output : 0/12V DC	V	
	DC mA, V (See Output Signal Code Table, Code : 4 to 8)	□	
	Triac (SSR) output	T	
Output 2 (OUT2)	Open collector output	D	
	No supplied	N	
	Relay contact output	M	
	Voltage pulse output : 0/12V DC	V	
Power supply	DC mA, V (See Output Signal Code Table, Code : 3 to 8)	□	
	Triac (SSR) output	T	
	Open collector output	D	
	24V AC/DC	3	
Optional function	100 to 240V AC	4	
	Not supplied	N	
	Digital input 5 points	A	
	Digital input 2 points + Remote setpoint input	B	
	Digital input 2 points + Feedback resistance input	C	
	Digital input 2 points + CT input 2 points	D	
	Digital input 3 points + Communication 1 point	E	
	Digital input 1 point + Communication 1 point + CT input 1 point	F	
	Communication 2 points	G	
	Communication 1 point + CT input 2 points	H	
	Digital input 1 point + Remote setpoint input + Analog retransmission output 0 to 1V DC	3	
	Digital input 1 point + Remote setpoint input + Analog retransmission output 0 to 5V DC	4	
Digital input 1 point + Remote setpoint input + Analog retransmission output 0 to 10V DC	5		
Digital input 1 point + Remote setpoint input + Analog retransmission output 1 to 5V DC	6		
Digital input 1 point + Remote setpoint input + Analog retransmission output 0 to 20mA	7		
Digital input 1 point + Remote setpoint input + Analog retransmission output 4 to 20mA	8		
Case color	White case	N	
	Black case	A	
Initial setting	No quick start code (Default setting)	N	
	Specify quick start code 1	1	
	Specify quick start code 1 and 2 (See page 11)	2	

Quick start code 1	Control Method		Quick start code 1
			No quick start code
Control Method	PID control with AT (Reverse action)		F
	PID control with AT (Direct action)		D
	Heat/Cool PID control with AT		G
	Heat/Cool PID control with AT for extruder (Air cooling type)		A
	Heat/Cool PID control with AT for extruder (Water cooling type)		W
	Position proportional PID control without FBR		Z
Input and range	No quick start code		No code
	See Input range Code Table		□□□
Instrument version	Version symbol		Y

• Universal input, no model code required on hardware code.

◆ Default setting

• Digital output (DO1, DO2) : Standard function

*1 : When Heat Control or Cool Control is selected, output 2 is available for Event Output, HBA Output and FAIL Output.

See Output Allocation Table (page 7).

*2 : See Digital Input (DI) Allocation Table (page 7).

*3 : When HBA (heater break alarm) is used, select the "CT input" from the model code.

Input range code table

Thermocouple

Input	Code	Range	Input	Code	Range
K	K : 35	-200.0 to +400.0°C	J	J : C7	-200.0 to +700.0°F
	K : 40	-200.0 to +800.0°C		J : C6	-328.0 to +1200.0°F
	K : 09	0.0 to 400.0°C		J : B6	0.0 to 800.0°F
	K : 10	0.0 to 800.0°C		J : B9	-328 to +2192°F
	K : 41	-200 to +1372°C		J : A1	0 to 800°F
	K : 02	0 to 400°C		J : A2	0 to 1600°F
	K : 04	0 to 800°C	T	T : 19	-200.0 to +400.0°C
	K : C6	-250.0 to +800.0°F		T : C2	-328.0 to +752.0°F
	K : C4	-328.0 to +400.0°F	S	S : 06	-50 to +1768°C
	K : A4	0.0 to 800.0°F		S : A7	-58 to +3214°F
	K : C5	-328 to +2502°F	R	R : 07	-50 to +1768°C
	K : A1	0 to 800°F		R : A7	-58 to +3214°F
	K : A2	0 to 1600°F	E	E : 21	-200.0 to +700.0°C
	J	J : 27		-200.0 to +400.0°C	E : 06
J : 32		-200.0 to +800.0°C		E : A9	-328.0 to +1292.0°F
J : 08		0.0 to 400.0°C		E : B1	-328 to +1832°F
J : 09		0.0 to 800.0°C		B	B : 03
J : 15		-200 to +1200°C	B : B2		0 to 3272°F
J : 02		0 to 400°C	N	N : A2	0 to 1300°C
J : 04	0 to 800°C	N : A7		0 to 2372°F	

RTD

Input	Code	Range
Pt100	D : 34	-100.00 to +100.00°C
	D : 35	-200.0 to +850.0°C
	D : 21	-200.0 to +200.0°C
	D : C8	-199.99 to +199.99°F
	D : C9	-328.0 to +1562.0°F
JpT100	P : 29	-100.00 to +100.00°C
	P : 30	-200.0 to +640.0°C
	P : C8	-199.99 to +199.99°F
	P : C9	-328.0 to +1184.0°F
	P : D1	-200.0 to +200.0°F

DC Current • voltage

Input	Code	Range
0 to 10mV	1 : 01	0.0 to 100.0%
0 to 100mV	2 : 01	
0 to 1V	3 : 01	
0 to 5V	4 : 01	
0 to 10V	5 : 01	
1 to 5V	6 : 01	

Input	Code	Range
0 to 20mA	7 : 01	0.0 to 100.0%
4 to 20mA	8 : 01	
-100 to +100mV	9 : 01	
-1 to +1V	9 : 02	
-10 to 10mV	9 : 03	

Output signal code table

3	0 - 1V DC	*	4	0 - 5V DC	5	0 - 10V DC	6	1 - 5V DC	7	0 - 20mA DC	8	4 - 20mA DC
---	-----------	---	---	-----------	---	------------	---	-----------	---	-------------	---	-------------

* 0 to 1 VDC output can be specified only for analog retransmission output.

Quick Start Code 2

● FB100

- Quick start code 2 tells the factory to ship with each parameter preset to the values detailed as specified by the customer. Quick start code is not necessarily specified when ordering, unless the preset is requested. These parameters are software selectable items and can be re-programmed in the field via the manual.

Specifications		Quick start code							
		□□□□	□-□	□	□	□-□	□	□	□
Output allocation	See output allocation table	□□							
Digital input allocation	See Digital input allocation table	□□							
Remote setpoint input signal	No Remote setpoint input signal								
	0 to 10mV DC								
	0 to 100mV DC								
	0 to 1V DC								
	0 to 5V DC								
	0 to 10V DC								
	1 to 5V DC								
	0 to 20mA DC								
Event 1 type	No event 1 See event type code table								
Event 2 type	No event 2 See event type code table								
Event 3 type	No event 3 See event type code table								
Event 4 type	No event 4 See event type code table Control loop break alarm (LBA)								
CT type	No CT1 and CT2								
	CT1 : CTL-6-P-N, CT2 : No use								
	CT1 : CTL-12-S56-10L-N, CT2 : No use								
	CT1 : CTL-6-P-N, CT2 : CTL-6-P-N CT1 : CTL-12-S56-10L-N, CT2 : CTL-12-S56-10L-N								
Communication 1	No communication 1 (COM1)								
	ANSI/RKC standard protocol								
	MODBUS protocol Inter-controller protocol								

Event Code Table (Programmable)

Code	Event type
A	Deviation High
B	Deviation Low
C	Deviation High/Low
D	Band
E	Deviation High with Alarm Hold
F	Deviation Low with Alarm Hold
G	Deviation High/Low with Alarm Hold
H	Process High
J	Process Low
K	Process High with Alarm Hold
L	Process Low with Alarm Hold
Q	Deviation High with Alarm Re-Hold
R	Deviation Low with Alarm Re-Hold
T	Deviation High/Low with Alarm Re-Hold
V	Set value High
W	Set value Low
1	MV value High
2	MV value Low
3	Cool side MV value High
4	Cool side MV value Low

- Default setting when no quick start code is specified.
CT type : CTL-6-P-N
Communication 2 : ANSI/RKC standard protocol
- Communication 2 is for inter-controller communication.

Output Allocation Table (Programmable) ♦ Default setting

Code	Output 1 (OUT 1)	Output 2 (OUT 2)	Digital Output 1 (DO 1)	Digital Output 2 (DO 2)
01	Control output 1	Control output 2	Event 1	Event 2
02	Control output 1	Control output 2	Event 1	Event 4
03	Control output 1	Control output 2	Event 1	HBA
04	Control output 1	Control output 2	Event 1	FAIL (De-energized)
05	Control output 1	Control output 2	Event 4	HBA
06	Control output 1	Control output 2	Event 4	FAIL (De-energized)
07	Control output 1	Control output 2	HBA	FAIL (De-energized)
08	Control output 1	HBA	Event 1	Event 2
09	Control output 1	HBA	Event 1	Event 4
10	Control output 1	HBA	Event 1	FAIL (De-energized)
11	Control output 1	HBA	Event 4	FAIL (De-energized)
12	Control output 1	FAIL (De-energized)	Event 1	Event 2
13	Control output 1	FAIL (De-energized)	Event 1	Event 4
14	Control output 1	Event 1	Event 2	Event 3
15	Control output 1	Event 4	Event 1	Event 2

- Energized/De-energized is configurable except for the FAIL output. (Factory default setting: Energized) (Caution)
- Invalid for a non-existing output/input function.
- When used as heating/cooling control/position proportioning control, select any code of 01 to 07.
- Remote/Local transfer can be done during cascade control and ratio control by inter-controller communication.

Digital input (DI) Allocation Table (Programmable) ♦ Default setting

Code	DI 1	DI 2	DI 3	DI 4	DI 5	Selectable optional Code
01	Unused					
02	Memory area selection (1 to 8)	Area set	RUN/STOP			A
03	Memory area selection (1 to 8)	Area set				
04	Memory area selection (1 to 8)	Area set	AUTO/MANUAL			
05	Memory area selection (1 to 8)	Area set	Alarm interlock reset			
06	Memory area selection (1 to 8)	RUN/STOP				
07	Memory area selection (1 to 8)	RUN/STOP	AUTO/MANUAL			
08	Memory area selection (1 to 8)	RUN/STOP	Alarm interlock reset			
09	Memory area selection (1 to 8)		AUTO/MANUAL			
10	Memory area selection (1 to 8)		Alarm interlock reset			
11	Memory area selection (1 to 8)	AUTO/MANUAL	Alarm interlock reset			
12	Memory area selection (1 to 8)					
13	RUN/STOP	REMOTE/LOCAL	AUTO/MANUAL			A, E
14	RUN/STOP	REMOTE/LOCAL	Alarm interlock reset			
15	RUN/STOP	AUTO/MANUAL	Alarm interlock reset			
16	REMOTE/LOCAL	AUTO/MANUAL	Alarm interlock reset			A, B, C, D, E
17	RUN/STOP	REMOTE/LOCAL				
18	RUN/STOP	AUTO/MANUAL				
19	RUN/STOP	Alarm interlock reset				
20	REMOTE/LOCAL	AUTO/MANUAL				
21	REMOTE/LOCAL	Alarm interlock reset				
22	AUTO/MANUAL	Alarm interlock reset				A, B, C, D, E, F 3, 4, 5, 6, 7, 8
23	RUN/STOP					
24	REMOTE/LOCAL					
25	AUTO/MANUAL					
26	Alarm interlock reset					

Temperature/Process Controller FB 100/400/900

Model and Suffix Code

● FB400/900

Specifications	Model and Suffix Code			
	Hardware coding only			Quick start code 1
Model	FB400 (48 x 96mm 1/8 DIN size) FB900 (96 x 96mm 1/4 DIN size)	-□□-□*□□□□/□□-□ □□□/ Y		
Output 1 (OUT1)	Relay contact output Voltage pulse output : 0/12V DC DC mA, mV, V (See Output Signal Code Table, Code : 4 to 8) Triac (SSR) output Open collector output	M V □ T D		
Output 2 (OUT2)	No supplied Relay contact output Voltage pulse output : 0/12V DC DC mA, mV, V (See Output Signal Code Table, Code : 3 to 8) Triac (SSR) output Open collector output	N M V □ T D		
Power supply	24V AC/DC 100 to 240V AC	3 4		
Digital output	No supplied DO 4 points (DO1 to DO4)	N 4		
CT input, Power feed forward (PFF) input, Feedback resistance	Not supplied CT input : 2 points PFF input (Within transformer 100 to 120V AC type) PFF input (Within transformer 200 to 240V AC type) CT input : 1 point + PFF input (Within transformer 100 to 120V AC type) CT input : 1 point + PFF input (Within transformer 200 to 240V AC type) Feedback resistance input	N T 1 2 3 4 F		
Retransmission output	No retransmission output DC mA, mV, V (See Output Signal Code Table, Code : 3 to 8)	N □		
Communication	Not supplied Communication 1 : RS-232C, Communication 2 : Not supplied Communication 1 : RS-422A, Communication 2 : Not supplied Communication 1 : RS-485, Communication 2 : Not supplied Communication 1 : RS-232C, Communication 2 : RS-485 Communication 1 : RS-485, Communication 2 : RS-485 Communication 1 : Not supplied, Communication 2 : RS-485 Digital input : 4 points (DI1 to DI4) <Area selection>	N 1 4 5 W X Y D		
Case color	White case Black case	N A		
Initial setting	No quick start code (Default setting) Specify quick start code 1 Specify quick start code 1 and 2 (See page 11)	N 1 2		
Quick start code 1	No quick start code PID control with AT (Reverse action) PID control with AT (Direct action) Heat/Cool PID control with AT Heat/Cool PID control with AT for extruder (Air cooling type) Heat/Cool PID control with AT for extruder (Water cooling type) Position proportional PID control without FBR		No code F D G A W Z	
Input and range	No quick start code See Input range Code Table		No code □□□	
Instrument version	Version symbol			Y

- Universal input, no model code required on hardware code.
- * When HBA (heater break alarm) is used, select the "CT input" from the model code.
- ** When inter-controller communication is used, please specify code "W, X or Y (COM2 : RS-485).

Input range code table

Thermocouple

Input	Code	Range	Input	Code	Range
K	K : 35	-200.0 to +400.0°C	J	J : C7	-200.0 to +700.0°F
	K : 40	-200.0 to +800.0°C		J : C6	-328.0 to +1200.0°F
	K : 09	0.0 to 400.0°C		J : B6	0.0 to 800.0°F
	K : 10	0.0 to 800.0°C		J : B9	-328 to +2192°F
	K : 41	-200 to +1372°C		J : A1	0 to 800°F
	K : 02	0 to 400°C		J : A2	0 to 1600°F
	K : 04	0 to 800°C	T	T : 19	-200.0 to +400.0°C
	K : C6	-250.0 to +800.0°F		T : C2	-328.0 to +752.0°F
	K : C4	-328.0 to +400.0°F	S	S : 06	-50 to +1768°F
	K : A4	0.0 to 800.0°F		S : A7	-58 to +3214°F
	K : C5	-328 to +2502°F	R	R : 07	-50 to +1768°C
	K : A1	0 to 800°F		R : A7	-58 to +3214°F
	K : A2	0 to 1600°F	E	E : 21	-200.0 to +700.0°C
	J	J : 27		-200.0 to +400.0°C	E : 06
J : 32		-200.0 to +800.0°C		E : A9	-328.0 to +1292.0°F
J : 08		0.0 to 400.0°C		E : B1	-328 to +1832°F
J : 09		0.0 to 800.0°C	B	B : 03	0 to 1800°C
J : 15	-200 to +1200°C	B : B2		0 to 3272°F	
J : 02	0 to 400°C	N	N : 02	0 to 1300°C	
J : 04	0 to 800°C		N : A7	0 to 2372°F	

RTD

Input	Code	Range
Pt100	D : 34	-100.00 to +100.00°C
	D : 35	-200.0 to +850.0°C
	D : 21	-200.0 to +200.0°C
	D : C8	-199.99 to +199.99°F
	D : C9	-328.0 to +1562.0°F
	JPt100	P : 29
P : 30		-200.0 to +640.0°C
P : C8		-199.99 to +199.99°F
P : C9		-328.0 to +1184.0°F
P : D1		-200.0 to +200.0°F

DC Current • voltage

Input	Code	Range
0 to 10mV	1 : 01	0.0 to 100.0%
0 to 100mV	2 : 01	
0 to 1V	3 : 01	
0 to 5V	4 : 01	
0 to 10V	5 : 01	
1 to 5V	6 : 01	

Input	Code	Range
0 to 20mA	7 : 01	0.0 to 100.0%
4 to 20mA	8 : 01	
-100 to +100mV	9 : 01	
-1 to +1V	9 : 02	
-10 to 10mV	9 : 03	

Output signal code table

3	0 - 1V DC	*	4	0 - 5V DC	5	0 - 10V DC	6	1 - 5V DC	7	0 - 20mA DC	8	4 - 20mA DC
---	-----------	---	---	-----------	---	------------	---	-----------	---	-------------	---	-------------

* 0 to 1 VDC output can be specified only for analog retransmission output.

Temperature/Process Controller **FB100/400/900**

Quick Start Code 2

● FB400/900

- Quick start code 2 tells the factory to ship with each parameter preset to the values detailed as specified by the customer. Quick start code is not necessarily specified when ordering, unless the preset is requested. These parameters are software selectable items and can be re-programmed in the field via the manual.

Specifications	Initial Setting Code								
	□ □ - □ □ □ □ □ □ □ □								
Output logic selection	See output logic code table. □								
Remote setpoint input signal	0 to 10mV DC	1							
	0 to 100mV DC	2							
	0 to 1V DC	3							
	0 to 5V DC	4							
	0 to 10V DC	5							
	1 to 5V DC	6							
	0 to 20mA DC	7							
	4 to 20mA DC	8							
Event 1 type	Not supplied See event type code table					N			
Event 2 type	Not supplied See event type code table						N		
Event 3 type	Not supplied See event type code table							N	
Event 4 type	Not supplied See event type code table LBA (Control loop break alarm)							N □ 5	
CT type	No CT1 and CT2 CT1 : CTL-6-P-N, CT2 : No use CT1 : CTL-12-S56-10L-N, CT2 : No use CT1 : CTL-6-P-N, CT2 : CTL-6-P-N CT1 : CTL-12-S56-10L-N, CT2 : CTL-12-S56-10L-N								N P S T U
Communication 1 protocol	Not supplied ANSI/RKC standard MODBUS								N 1 2

* Please specify "8" when the remote setpoint input signal is not used.

Output Logic Code Table.

Output 1 (OUT 1)	Output 2 (OUT 2)	Digital Output 1 (DO 1)	Digital Output 2 (DO 2)	Digital Output 3 (DO 3)	Digital Output 4 (DO 4)	Code
Control output 1	Control output 2	Event 1	Event 2	Event 3	Event 4	1
Control output 1	Control output 2	Event 1	Event 2	Event 3	HBA	2
Control output 1	Control output 2	Event 1	Event 2	HBA	FAIL (De-energized)	3
Control output 1	Control output 2	Event 1	HBA	Event 3	Event 4	4
Control output 1	HBA	Event 1	Event 2	Event 3	Event 4	5
Control output 1	HBA	Event 1	Event 2	Event 3	FAIL (De-energized)	6
Control output 1	FAIL (De-energized)	Event 1	Event 2	Event 3	Event 4	7

Event Type Code Table.

Event type	Code
Deviation High	A
Deviation Low	B
Deviation High/Low	C
Band	D
Deviation High with Alarm Hold	E
Deviation Low with Alarm Hold	F
Deviation High/Low with Alarm Hold	G
Process High	H
Process Low	J
Process High with Alarm Hold	K
Process Low with Alarm Hold	L
Deviation High with Alarm Re-Hold	Q
Deviation Low with Alarm Re-Hold	R
Deviation High/Low with Alarm Re-Hold	T
Set value High	V
Set value Low	W
MV value High	1
MV value Low	2
Cool side MV value High	3
Cool side MV value Low	4

- Energized/De-energized is configurable except for the FAIL output. (Factory default setting: Energized)
- Invalid for a non-existing output/event function. (Caution)
- When used as heating/cooling control/position proportioning control, select any code of 1 to 4.

Accessory

Current transformer for heater break alarm (HBA) (Sold separately)

Model code
CTL-6-P-N (0 to 30A)
CTL-12-S56-10L-N (0 to 100A)

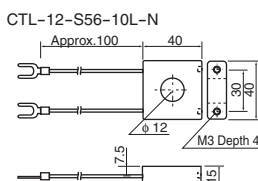
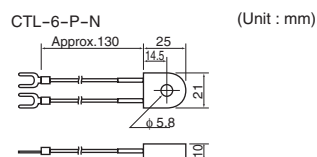

Terminal cover (Sold separately)

Type	Model Code
FB400/900	KFB400-58
FB100	KCA100-517

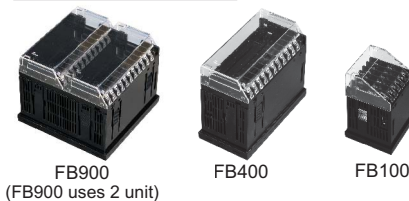

Front cover (Sold separately)

Type	Model Code
FB900	KRB900-36
FB400	KRB400-36
FB100	KRB100-36

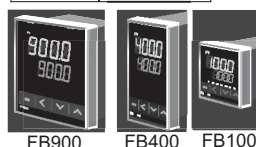

(For Power feed forward input)

* Supplied when power feed forward function is specified.

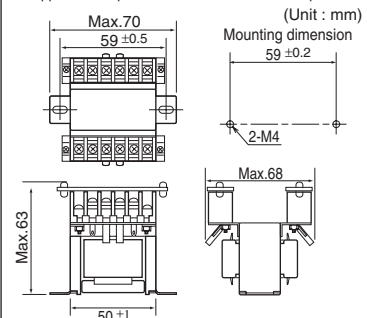

* When ordering transformer for replacement, please specify one of the following model codes.
100 to 120V AC type : PFT-01
200 to 240V AC type : PFT-02

External Dimensions

Unit : mm

FB100

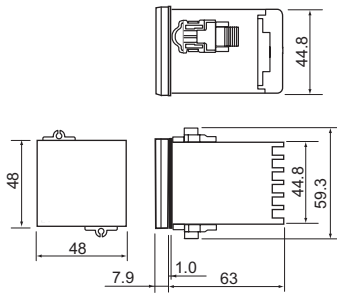

Panel Cutout

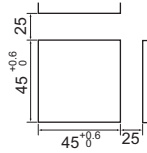

(Panel thickness must be between 1 to 10mm)

(Close horizontal mounting)
* Up to 6 units

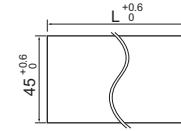

$$L = (48Xn - 3) \begin{matrix} +0.6 \\ 0 \end{matrix}$$

n : Number of controllers
(2=<n=<6)

FB400

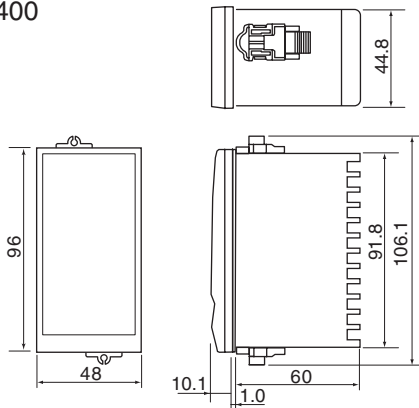

Panel Cutout

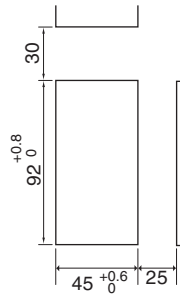

(Panel thickness must be between 1 to 10mm)

(Close horizontal mounting)
* Up to 6 units

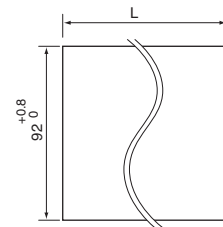

$$L = (96Xn - 4) \begin{matrix} +0.8 \\ 0 \end{matrix}$$

n : Number of controllers
(2=<n=<6)

FB900

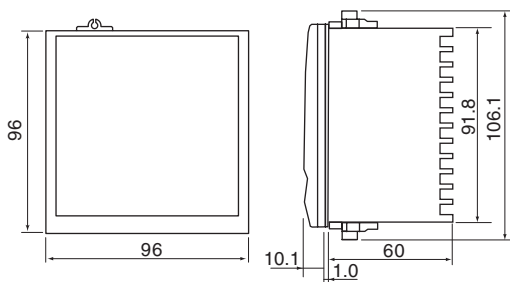

Panel Cutout

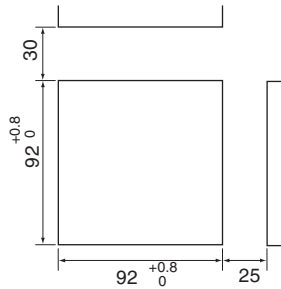

(Panel thickness must be between 1 to 10mm)

(Close horizontal mounting)
* Up to 6 units

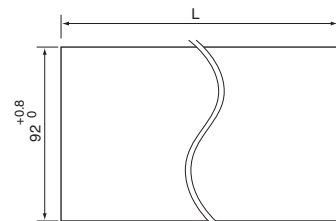

$$L = (48Xn - 3) \begin{matrix} +0.6 \\ 0 \end{matrix}$$

n : Number of controllers
(2=<n=<6)

• Waterproof/dustproof is not available for close horizontal mounting.

Temperature/Process Controller FB 100/400/900

Rear Terminals

FB100

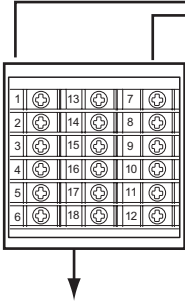

• Use a solderless terminal for screw size M3, width 5.8mm or less.

No	Description	No	Description
1	AC L DC + 100-240V 24V 24V L N - -	7	COM
2		8	DO1
3	NO	9	DO2
4	TRIA C (1) (2) (3) (4)	10	A
5	NO	11	B
6	TRIA C (1) (2) (3) (4)	12	(1) (2) (3)

Optional function terminals

Optional function: Code A		Optional function: Code B		Optional function: Code C		Optional function: Code D		Optional function: Code E	
No	Description	No	Description	No	Description	No	Description	No	Description
13	COM Digital input	13	COM Digital input	13	COM Digital input	13	COM Digital input	13	SG COM Communication 1
14	DI1 DI1 to DI5 Non voltage contact input	14	DI1 DI1 to DI2 Non voltage contact input	14	DI1 DI1 to DI2 Non voltage contact input	14	DI1 DI1 to DI2 Non voltage contact input	14	T/R(A) RS-485
15	DI2	15	DI2	15	DI2	15	DI2	15	T/R(B) Non voltage contact input
16	DI3	16		16	OPEN (O) Feedback resistance input	16	COM CT1,CT2 input	16	DI1 Digital input
17	DI4	17	IN Remote setpoint input	17	(W)	17	CT1	17	DI2 DI1 to DI3 Non voltage contact input
18	DI5	18	- Remote setpoint input	18	CLOSE (C)	18	CT2	18	DI3
Optional function: Code F		Optional function: Code G		Optional function: Code H		Optional function: Code 3,4,5,6,7,8		CT : Current transformer for heater break alarm	
No	Description	No	Description	No	Description	No	Description		
13	SG COM Communication 1	13	SG Communication 1	13	SG Communication 1	13	COM Digital input (DI1) Non voltage contact input		
14	T/R(A) RS-485	14	T/R(A) RS-485	14	T/R(A) RS-485	14	DI1		
15	T/R(B) Digital input (DI1) Non voltage contact input	15	T/R(B) RS-485	15	T/R(B) RS-485	15	IN Remote setpoint input		
16	DI1	16	SG Communication 2	16	COM CT1,CT2 input	16	- Remote setpoint input		
17	CT1 CT1 input	17	T/R(A) RS-485	17	CT1	17	AO Analog retransmission output		
18		18	T/R(B)	18	CT2	18	-		

FB400

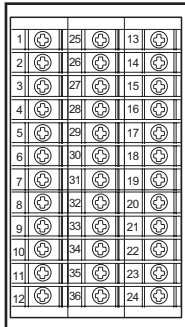

FB900

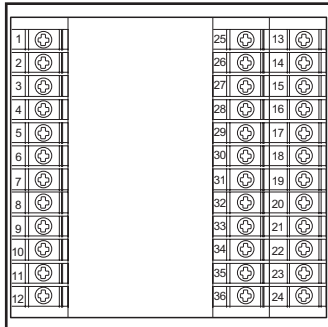

• Use a solderless terminal for screw size M3X6.

No	Description	No	Description	No	Description
1	AC L DC + 100-240V 24V 24V L N - -	25	SG SG SG Communication (*)	13	COM Digital input (Mode selection)
2		26	SD T/R(A) T(A) Communication 1	14	DI 5 DI5 to DI7 Non voltage contact input
3	COM Digital output 3, 4 (DO 3, 4) Relay contact output (*)	27	(1) RD T/R(B) T(B) (2) Communication 1	15	DI 6
4	DO4	28	(3) R(A) T/R(A) Communication 2	16	DI 7
5	DO3	29	(4) R(B) T/R(B) Communication 2	17	COM (A) OPEN (O) (B) COM (C) (1) CT1,CT2 input (*)
6	COM Digital output 1, 2 (DO 1, 2) Relay contact output (*)	30	COM Digital input (Memory area selection) (DI 1 to DI4) Non voltage contact input (*)	18	CT1 (2) Feedback resistance input
7	DO2	31	(1) DI 1	19	CT2 (3) CT1 input + Power feed forward input
8	DO1	32	(2) DI 2	20	Remote setpoint input
9	Main output (OUT2) (1) Relay contact output (2) Voltage pulse / Current/Voltage (3) SSR (Triac) / Open collector	33	(4) DI 3	21	Remote setpoint input
10	Main output (OUT1) (1) Relay contact output (2) Voltage pulse / Current/Voltage (3) SSR (Triac) / Open collector	34	(SET) DI 4	22	Measured input
11	NO	35	AO Analog retransmission output (AO) (*)	23	(A) Thermocouple (B) RTD (C) Voltage/Current
12		36		24	

(*) Optional

CT : Current transformer for heater break alarm
PFF : Power feed forward transformer